

LACE CLOTH SET | Industrial Model N°80078 and 80278

Tall version

LC

Technology:

Perforated Aluminium 3mm thick sheet, folded and welded.

Color:

White

Finish:

Polyester thermosetting powder coating.

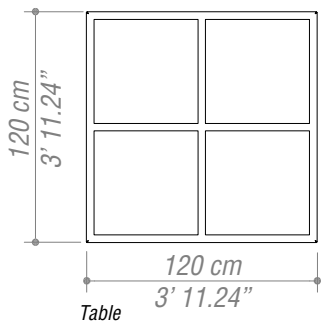
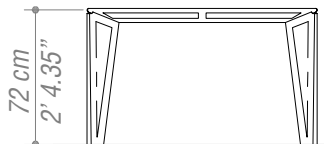
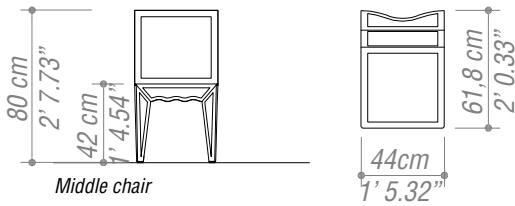
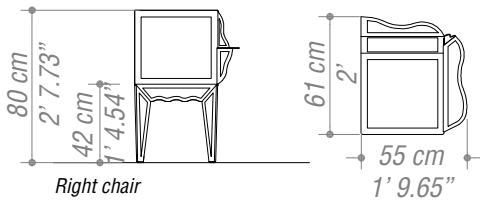
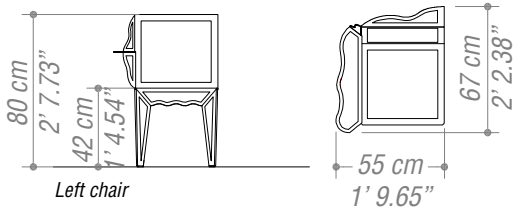

Industrial Model and Design registered No. 80078/80278

File: **Conj. MdeEncaje - ENG.dwg**

Scale: **1:50**

Version: **2015**

ALL RIGHTS RESERVED TO ESTUDIO CABEZA®



ESTUDIO CABEZA®

Pje. Soria 5020

C1414BLD

Buenos Aires

Argentina

Tel: 54-11-4833-2002

Fax: 54-11-4833-2002

info@estudiocabeza.com

www.estudiocabeza.com

LACE CLOTH SET | Industrial Model N°80078 and 80278

Low version

LC

Technology:

Perforated Aluminium 3mm thick sheet, folded and welded.

Color:

White

Finish:

Polyester thermosetting powder coating.

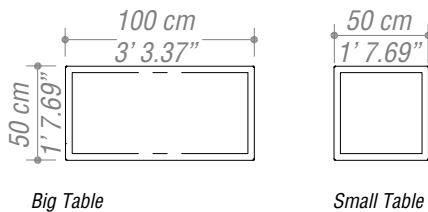
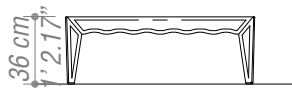
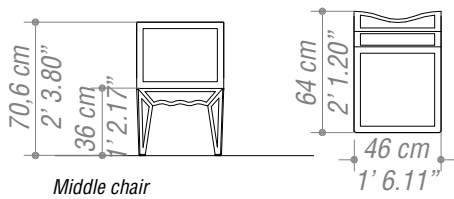
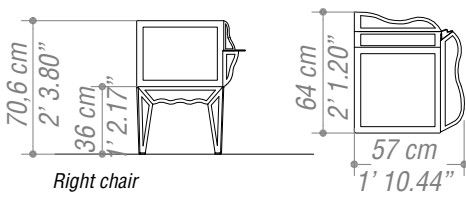
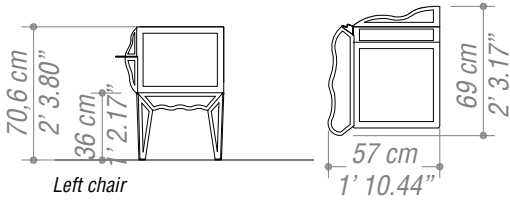

Industrial Model and Design registered No. 80078/80278

File: **Conj. MdeEncaje - ENG.dwg**
 Scale: **1:50**
 Version: **2015**

ALL RIGHTS RESERVED TO ESTUDIO CABEZA®



ESTUDIO CABEZA®

Pje. Soria 5020
 C1414BLD
 Buenos Aires
 Argentina

Tel: 54-11-4833-2002
 Fax: 54-11-4833-2002
 info@estudiocabeza.com
 www.estudiocabeza.com