

LACE CLOTH SET | Industrial Model N°80078 and 80278

Tall version

LC

Technology:

Perforated Aluminium 3mm thick sheet, folded and welded.

Color:

White

Finishing:

Polyester thermosetting powder coating.

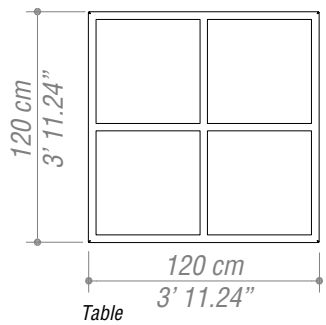
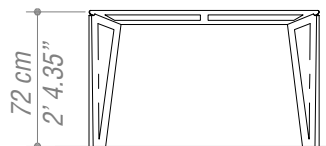
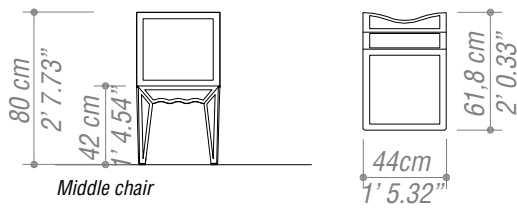
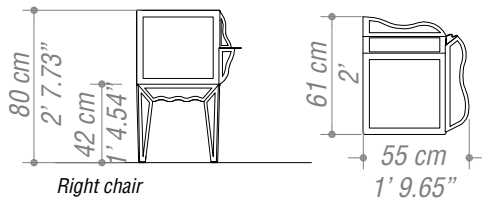
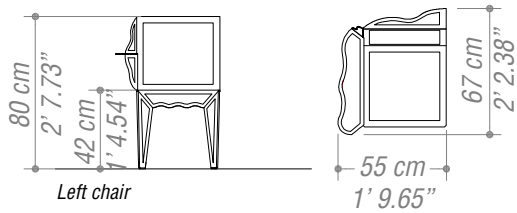

Industrial Model and Design registered No. 80078/80278

File: Conj. MdeEncaje - ENG.dwg
Scale: 1:50
Version: 2015

ALL RIGHTS RESERVED TO ESTUDIO CABEZA®



Pje. Soria 5020
C1414BLD
Buenos Aires
Argentina

Tel: 54-11-4833-2002
Fax: 54-11-4833-2002
info@estudiocabeza.com
www.estudiocabeza.com

LACE CLOTH SET | Industrial Model N°80078 and 80278

Low version

LC

Technology:

Perforated Aluminium 3mm thick sheet, folded and welded.

Color:

White

Finishing:

Polyester thermosetting powder coating.

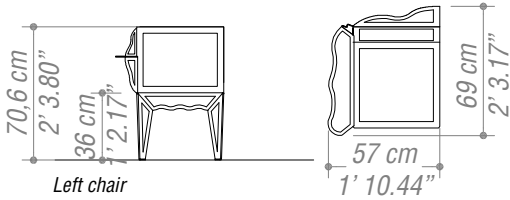

Left chair

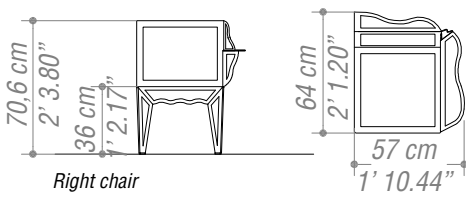

Right chair

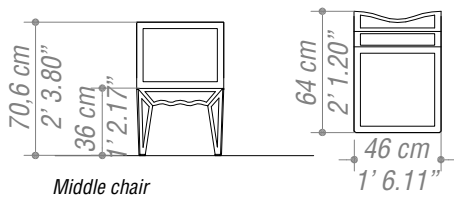

Middle chair

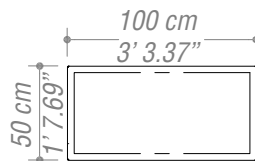
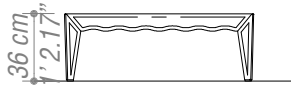

Big Table

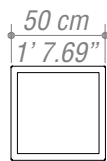

Small Table



Industrial Model and Design registered No. 80078/80278

File: Conj. MdeEncaje - ENG.dwg
Scale: 1:50
Version: 2015

ALL RIGHTS RESERVED TO ESTUDIO CABEZA®



Pje. Soria 5020
C1414BLD
Buenos Aires
Argentina

Tel: 54-11-4833-2002
Fax: 54-11-4833-2002
info@estudiocabeza.com
www.estudiocabeza.com